

BOSCH

September 2002

INDUSTRIAL

18V JIGSAW

Model 0601598360

52318

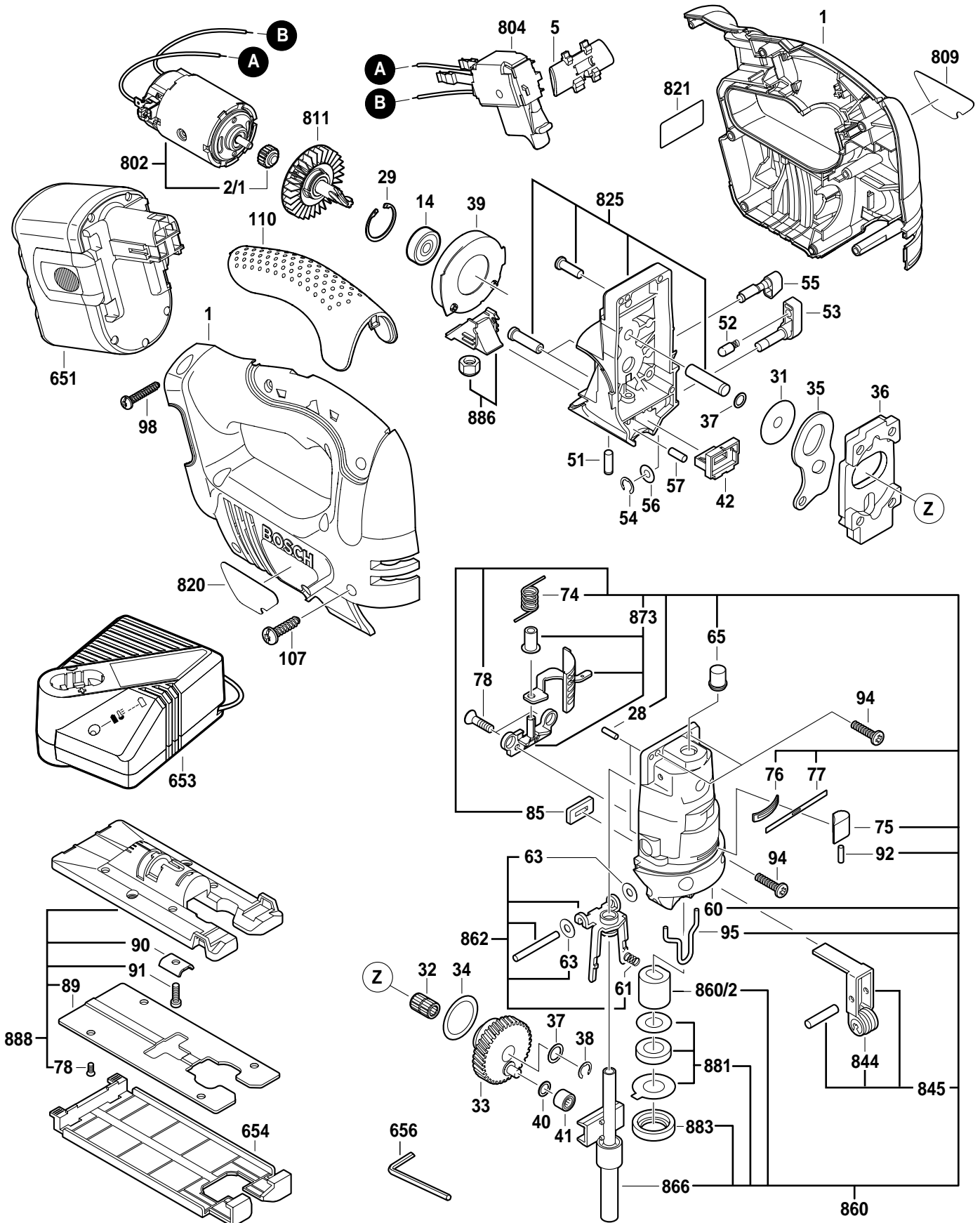

52318 18V JIGSAW

Pos.	Part Number	Description {Qty.}	F/C	Pos.	Part Number	Description {Qty.}	F/C
1	2 605 105 018	Housing	71	91	2 910 141 197	Screw	89
2/1	2 606 490 088	Clutch	67	92	2 603 101 050	Pin	66
5	2 601 099 120	Lever	9	94	2 603 410 049	Screw {4}	89
14	2 600 905 095	Ball Bearing	61	95	2 603 101 046	Guard	92
28	1 903 201 042	Pin {2}	66	98	2 914 201 668	Screw	89
29	2 916 669 008	Retaining Ring	89	107	2 914 201 707	Screw {7}	89
31	2 600 101 048	Shim	65	110	2 608 040 204	Cover	74
32	2 600 913 007	Needle Bearing	56	651	2 607 335 401	Battery 18V	18
33	2 606 320 088	Eccentric Gear	34	+ 652	2 609 100 101	Battery Cap	9
34	2 600 102 614	Shim	65	653	2 607 224 431	Multi-Volt Charger	18
35	2 601 923 010	Lever	9	654	2 608 000 184	Overshoe	9
36	2 601 098 032	Counterweight	68	656	1 907 950 006	Allen Wrench	9
37	2 600 101 047	Shim {2}	65	802	2 607 022 880	Motor Assembly	19
38	2 916 080 909	Circlip	89			w/pos. 2/1	
39	2 600 290 051	Air Deflector	24	804	2 607 200 413	Switch	17
40	2 600 200 038	Washer	65	809	2 601 116 129	Label	9
41	2 600 917 900	Needle Bearing	56	811	2 606 445 901	Coupling	33
42	2 602 305 050	Insert	9	820	2 601 116 130	Label	9
51	2 603 105 053	Pin	66	821	2 601 116 171	Nameplate	9
52	2 600 590 006	Cap/Spring	80	825	2 605 806 896	Gear Housing Assembly	72
53	2 602 026 063	Lever	64			w/pos. 57	
54	2 916 080 008	Circlip	89	844	2 600 326 904	Roller	87
55	2 602 026 065	Lever	64	845	2 601 321 904	Roller Guide Assembly	87
56	2 600 100 607	Shim	65			w/pos. 85, 844	
57	2 603 100 069	Pin	66	860	2 605 808 927	Gear Cover Assembly	70
60	2 605 808 081	Gear Cover	70	860/2	2 600 301 037	Bushing	51
61	2 604 610 042	Spring {2}	27	862	2 601 322 900	Guide Bracket Assembly	62
63	2 600 101 095	Shim {2}	65			w/pos. 61, 63	
65	2 601 015 064	Seal	77	866	2 600 780 911	Plunger Assembly	52
74	2 604 651 011	Spring	27	873	2 601 990 903	Plate Assembly	9
75	2 600 591 010	Cap	64			w/pos. 75, 92	
76	2 601 015 065	Seal	77	881	2 600 290 902	Seal Assembly	77
77	2 601 016 079	Plate	9	883	2 600 202 037	Retaining Ring	89
78	2 914 439 402	Screw {6}	89	886	2 605 500 911	Nut Assembly	89
85	2 601 015 057	Gasket	79	888	2 608 000 920	Base Plate Assembly	88
89	2 601 098 082	Base Plate	88			w/pos. 78, 89, 90, 91	
90	2 601 030 022	Plate	9				

Service Notes: